

Aanzicht B
Schaal: 1:15

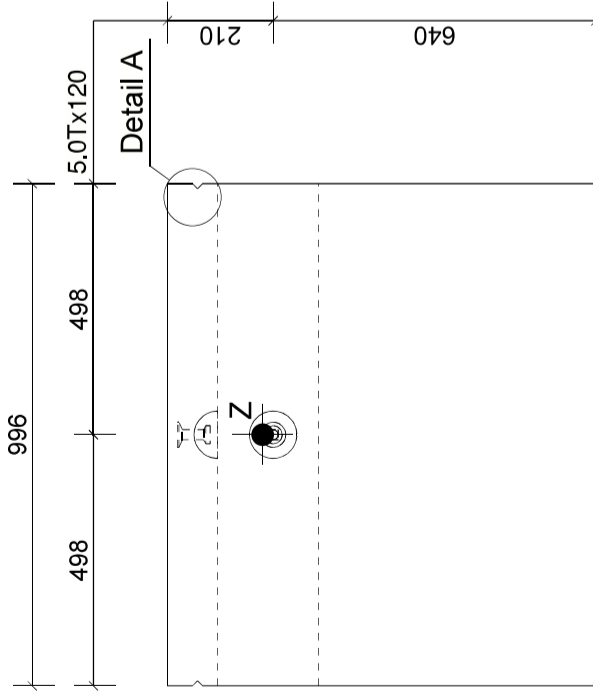

Aanzicht A
Schaal: 1:15

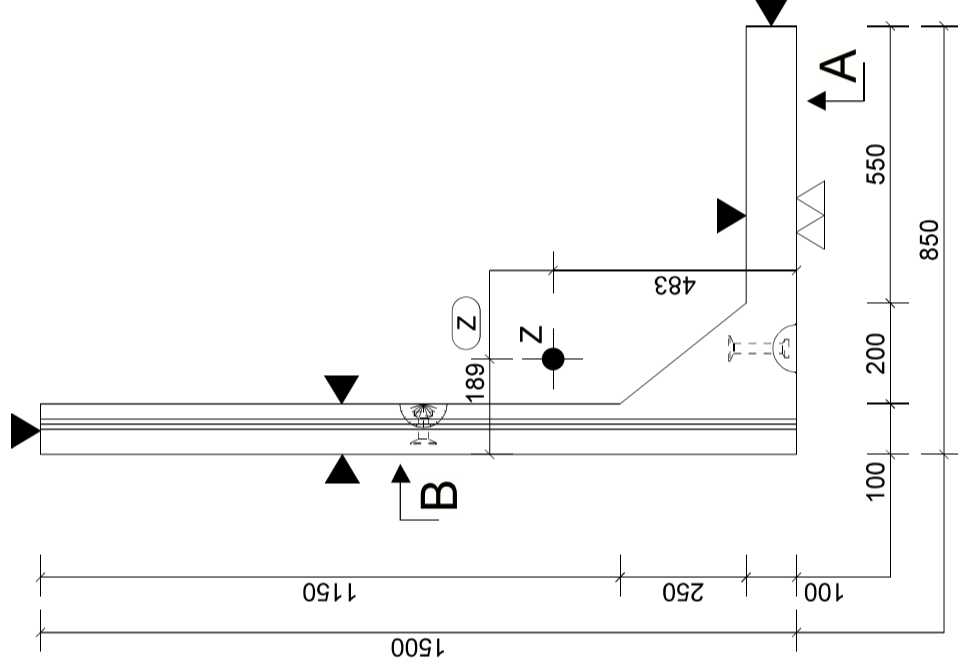

Doorsnede
Schaal: 1:15

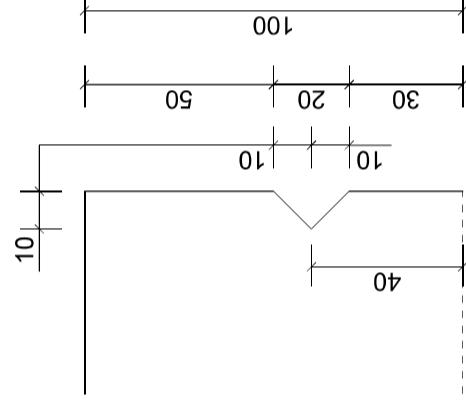

Detail A, 1:2

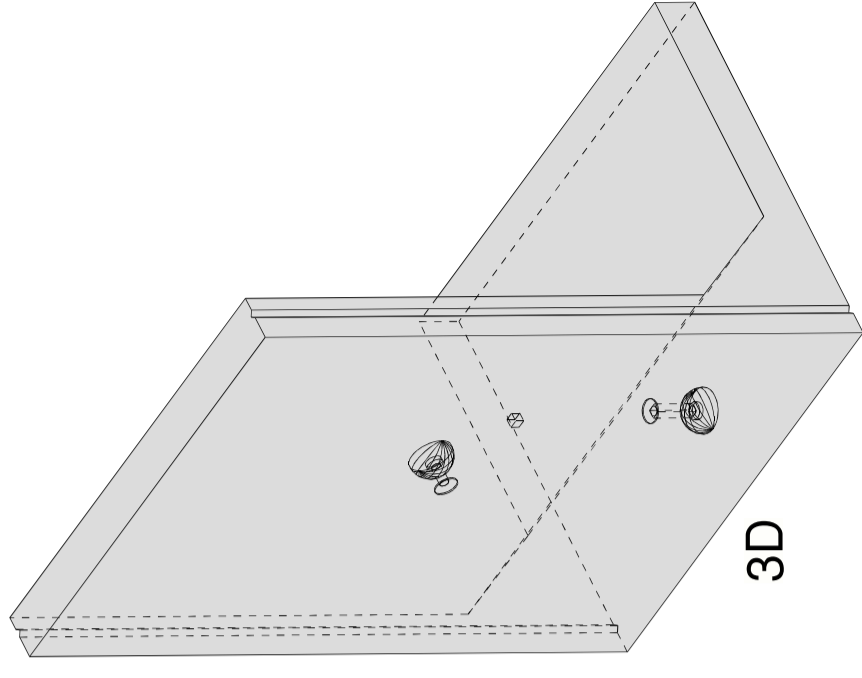

3D

Ia22	STAR	5.0T x 120	1701004	TV	1
Ia4	STAR	5T x 65	1701002	TV	1
Code	Benaming	Afmeting	Art.nr.	Materiaal	Aant.

Instortvoorzieningen

Getekend:	AA	STANDARD KEERWAND
Berekend:	JVE	
Controle:	CB	
Vrijgave:	AL	
Status:	DEFINITIEF	
Revisie:	0.0	
Datum:	15.11.2023	
Wijziging:		

Volume m3:	0.249
Gewicht (kg):	598
Aantal:	1

kemper
Postbus 11
6669 ZG Dodewaard
www.kemper.nl
013-4651851

Artikelnummer - tekening(merk)nummer
150 LT1